

# FRESH MAKER - ICE WATER 45



# FM Series



**FRESH MAKER**



**ICE WATER 45**

## **Produttori automatici di ghiaccio in cubetti con distributore di acqua raffreddata.**

Cubetti di qualità: compatti, freddi e cristallini.  
Acqua fresca in continuo, per un uso a volontà.  
Il FRESH MAKER per le sue dimensioni ridotte, è facilmente inseribile in arredamenti anche domestici.  
Il modello ICE WATER è adatto per mense, self-service, comunità.



## **Automatic ice cube maker with chilled water dispenser.**





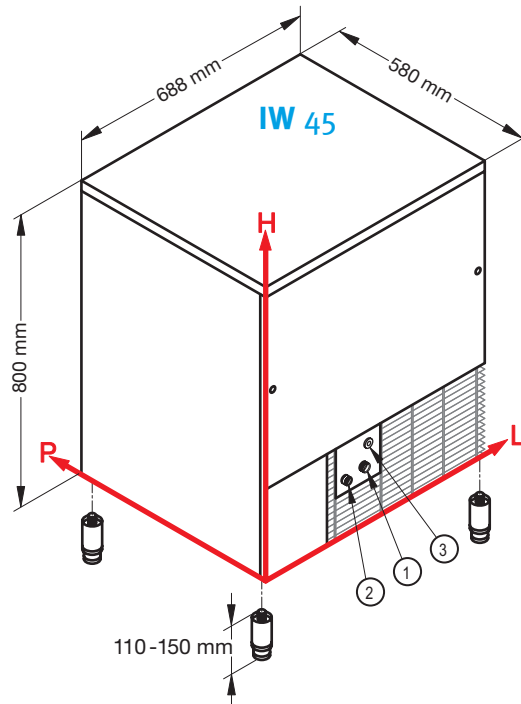
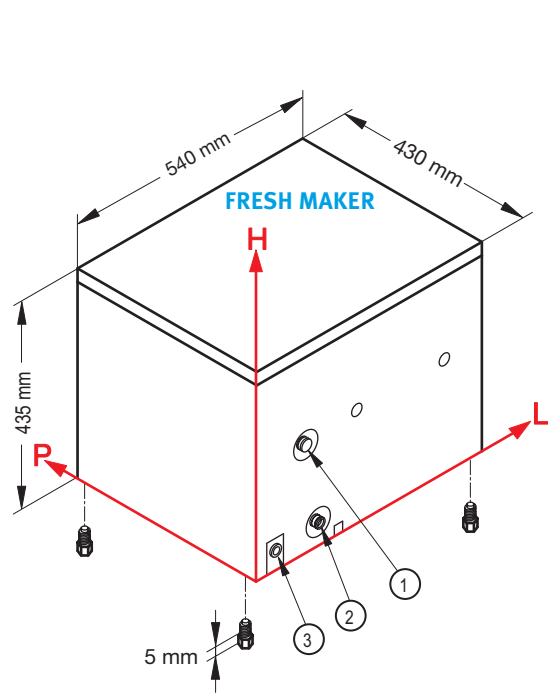



*Quality cubes: compact, cold and crystalline.  
Continuous supply of cold water for unlimited use.  
The FRESH MAKER for its small size, fits easily any furnishings, even domestic.  
The ICE WATER is suitable for canteens, self-services and other large catering structures.*

## **Machines à glaçons avec le distributeur d'eau fraîche.**

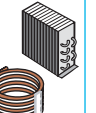
*Cubes de qualité: compacts et cristallins.  
Eau fraîche pour une utilisation à volonté.  
FRESH MAKER de dimensions réduites, ce modèle peut être facilement encastré dans n'importe quel meuble même domestique.  
ICE WATER adapté pour les cantines, self service, collectivités.*



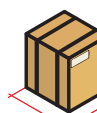

	1 			2 			3 		
	L	H	Ø	L	H	Ø	L	H	Ø
<b>FRESH MAKER</b>	120	215	3/4"	150	40	24mm	44	40	-
<b>IW 45</b>	299	196	3/4"	237	151	24mm	344	232	-

	Produzione in 24 h, sino a Production in 24 h, till Production en 24 h, jusqu'à	Capacità contenitore Storage capacity Réserve	Acqua erogata Water delivery Eau Fraîche	Raffreddamento Cooling system Condenseur	Tipo di cubetto Kind of cube Type de glaçon	Refrigerante Refrigerant Fluide réfrigérant	Voltaggio standard Standard voltage Tension standard	Potenza assorbita Input power Puissance absorbée	Consumo acqua (l/kg) Water consumption (l/kg) Consommation d'eau (l/kg)	Dimensioni (LxPxH) Sizes (MxDxH) Dimension (LxPxH)	Dimensioni con imballo (LxPxH) Sizes with packing (MxDxH) Dimension avec emballage (LxPxH)	Peso netto/lordo Weight net/gross Poids net/brut
							<b>V/Hz</b>	<b>W</b>				
<b>FRESH MAKER</b>	21 Kg	4 Kg circa 310	1,2 l/min	W	D - 13g	R404A	220-240 V~ 50 Hz	320 W	W 37,4	mm 540x430x435	mm 590x490x605	35/40 Kg
<b>IW 45</b>	42 Kg	25 Kg circa 1470	2 l/min	A / W	D - 13g A - 18g C - 33g E - 42g	R404A	220-240 V~ 50 Hz	450 W	A 4 W 15	mm 688x580x800	mm 730x620x960	71/80 Kg



Finitura: acciaio inox 18/8, scotch brite - Finishing: 18/8 stainless steel, scotch brite - Carrosserie: inox 18/8, scotch brite.



Condizioni  
Conditions / Conditions

 +21°C  +15°C  13g FM  
18g IW

Watt + 43°C  (230/50)

	 °C	 °C	Volt	
Minimum	+10 °C	+3 °C	-10 %	1bar (14psi)
Maximum	+43 °C	+32 °C	+10 %	6bar (84psi)

