

CB 640 / CB 840 / CB 955



**CB** Series



CB 640/840



CB 955



**Produttori automatici di ghiaccio in cubetti  
- sistema a spruzzo.**

Cubetti di qualità: compatti, freddi e cristallini.  
Il ghiaccio prodotto cade nel contenitore di raccolta ghiaccio.  
Particolarmente adatti ai locali con forti necessità di  
ghiaccio in ristrette fasce orarie.

**Automatic ice cube maker - spray sistem.**

*Quality cubes: compact, cold and crystalline.  
The ice produced drops into the ice collection bin.  
Particularly suitable for activities with large-scale ice  
demands in limited time-spans.*

**Machines à glaçons - système à projection d'eau.**



*Cubes de qualité: compacts et cristallins.  
La glace produite tombe dans la réserve.  
Particulièrement adaptés aux locaux nécessitant de grandes  
quantités de glace dans des phases horaires limitées.*





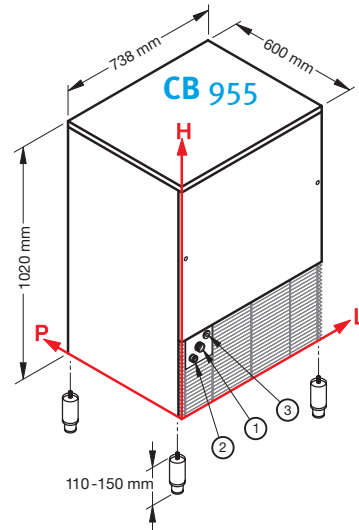
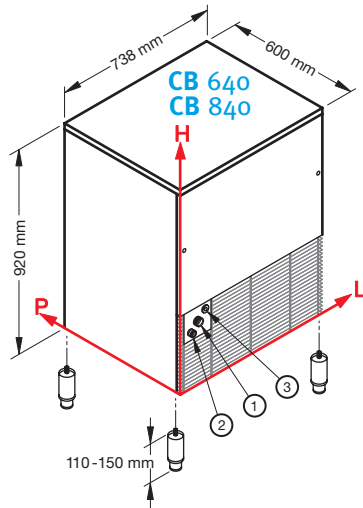





# CB Series

# CB 640-840 / CB 955

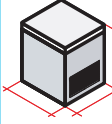
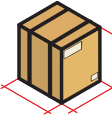

	1 			2 			3 		
	L	H	Ø	L	H	Ø	L	H	Ø
<b>CB 640</b>	116	285	3/4"	54	240	24mm	161	321	-
<b>CB 840</b>	116	285	3/4"	54	240	24mm	161	321	-
<b>CB 955</b>	116	285	3/4"	54	240	24mm	161	321	-

	Produzione in 24 h, sino a Production in 24 h, till Production en 24 h, jusqu'à	Capacità contenitore Storage capacity Réserve	Raffreddamento Cooling system Condenseur	Tipo di cubetto Kind of cube Type de glaçon	Refrigerante Refrigerant Fluide réfrigérant	Voltaggio standard Standard voltage Tension standard	Potenza assorbita Input power Puissance absorbée	Consumo acqua (l/kg) Water consumption (l/kg) Consommation d'eau (l/kg)	Dimensioni (LxPxH) Sizes (WxDxH) Dimension (LxPxH)	Dimensioni con imballo (LxPxH) Sizes with packing (WxDxH) Dimension avec emballage (LxPxH)	Peso netto/lordo Weight net/gross Poids net/brut
						<b>V/Hz</b>	<b>W</b>				
<b>CB 640</b>	65 Kg	40 Kg circa 2350	A / W	D - 13g A - 18g C - 33g E - 42g	R404A	220-240 V~ 50 Hz	650 W	A 2,8 W 12,8	mm 738x600x920	mm 780x640x1085	77/89 Kg
<b>CB 840</b>	80 Kg	40 Kg circa 2350	A / W	D - 13g A - 18g C - 33g E - 42g	R404A	220-240 V~ 50 Hz	800 W	A 2,6 W 14,4	mm 738x600x920	mm 780x640x1085	86/98 Kg
<b>CB 955</b>	90 Kg	55 Kg circa 3240	A / W	D - 13g A - 18g C - 33g E - 42g	R404A	220-240 V~ 50 Hz	850 W	A 2,5 W 14,2	mm 738x600x1020	mm 780x640x1185	89/102 Kg

Finitura: acciaio inox 18/8, scotch brite - Finishing: 18/8 stainless steel, scotch brite - Carrosserie: inox 18/8, scotch brite.





Condizioni  
Conditions / Conditions



+21°C +15°C 18g

Watt + 43°C  (230/50)

			Volt	
Minimum	+10 °C	+3 °C	-10 %	1bar (14psi)
Maximum	+43 °C	+32 °C	+10 %	6bar (84psi)



www.bremaice.it  
info@bremaice.it